

Super Audio CD Player

Operating Instructions



SUPER AUDIO CD



SCD-CE775

WARNING

To prevent fire or shock hazard, do not expose the unit to rain or moisture.

For the customers in the United States

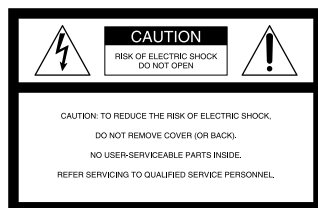

This symbol is intended to alert the user to the presence of uninsulated “dangerous voltage” within the product’s enclosure that may be of sufficient magnitude to constitute a risk of electric shock to persons.



This symbol is intended to alert the user to the presence of important operating and maintenance (servicing) instructions in the literature accompanying the appliance.

WARNING

This equipment has been tested and found to comply with the limits for a Class B digital device, pursuant to Part 15 of the FCC Rules. These limits are designed to provide reasonable protection against harmful interference in a residential installation. This equipment generates, uses, and can radiate radio frequency energy and, if not installed and used in accordance with the instructions, may cause harmful interference to radio communications. However, there is no guarantee that interference will not occur in a particular installation. If this equipment does cause harmful interference to radio or television reception, which can be determined by turning the equipment off and on, the user is encouraged to try to correct the interference by one or more of the following measures:

- Reorient or relocate the receiving antenna.
- Increase the separation between the equipment and receiver.
- Connect the equipment into an outlet on a circuit different from that to which the receiver is connected.
- Consult the dealer or an experienced radio/TV technician for help.

CAUTION

You are cautioned that any changes or modification not expressly approved in this manual could void your authority to operate this equipment.

Owner's Record

The model and serial numbers are located at the rear of the unit.

Record the serial number in the space provided below. Refer to them whenever you call upon your Sony dealer regarding this product.

Model No. SCD-CE775

Serial No. _____

CAUTION

This label is located on the LEFT exterior.



The use of optical instruments with this product will increase eye hazard.

As the laser beam used in this CD player is harmful to eyes, do not attempt to disassemble the cabinet. Refer servicing to qualified personnel only.

For the customers in Canada

This Class B digital apparatus complies with Canadian ICES-003.

CAUTION

TO PREVENT ELECTRIC SHOCK, DO NOT USE THIS POLARIZED AC PLUG WITH AN EXTENSION CORD, RECEPTACLE OR OTHER OUTLET UNLESS THE BLADES CAN BE FULLY INSERTED TO PREVENT BLADE EXPOSURE.

Welcome!

Thank you for purchasing the Sony Super Audio CD Player. Before operating the unit, please read this manual thoroughly and retain it for future reference.

About This Manual

The instructions in this manual are for model SCD-CE775.

Conventions

- Instructions in this manual describe the controls on the player. You can also use the controls on the remote if they have the same or similar names as those on the player.
- The following icons are used in this manual:



Indicates that you can do the task using the remote.



Indicates hints and tips for making the task easier.

Features

About the Super Audio CD

- Super Audio CD is a new high-quality audio disc standard where music is recorded in the DSD (Direct Stream Digital) format (conventional CDs are recorded in the PCM format). The DSD format, using a sampling frequency 64 times higher than that of a conventional CD, and with 1-bit quantization, achieves both a wide frequency range and a wide dynamic range across the audible frequency range, and so provides music reproduction extremely faithful to the original sound.
- The Super Audio CD has two types; a 2 channel stereo disc and a Multi-channel disc which holds up to 6 independent channels. The multi-channel characteristic of the Super Audio CD features a speaker allocation system basically similar to the 5.1 channel output of current AV systems.

Features of the player

This player is designed to play back 2-channel and multi-channel Super Audio CDs, and conventional CDs, and provides the following features:

- Mounted with a Discrete Dual Laser Optical Pickup, capable of reading a Super Audio CD or conventional CD depending on the exclusive wavelength.
- Quicker track access performance enabled by an advanced servo mechanism.
- A Multi-Channel Management function that allows you to adjust the multi-channel playback environment according to the allocation and size of your speakers.
- A Super Audio D/A Converter and Direct Digital Sync System, which allows higher-quality sound reproduction.
- Editing of Disc and Track Titles, etc., on a TEXT display for Super Audio CDs and conventional CDs.

Others

- A Super Audio CD can mark up to 255 track numbers. This feature applies to SCD-CE775.
- The supplied remote is capable of controlling both the SCD-CE775 and a conventional Sony CD player.

TABLE OF CONTENTS

Getting Started 4

- Before You Start the Hookup 4
- Hooking Up the Audio Components 4

Location and Functions of Parts 7

- Front Panel Parts Descriptions 7
- Rear Panel Parts Descriptions 8
- Remote Parts Descriptions 9

Playing Discs 10

- Compatible Disc Types 10
- Playing a Disc 11
- Using the Display 12
- Replacing Discs While Playing a Disc 15
- Locating a Specific Disc 16
- Locating a Specific Track 16
- Locating a Particular Point in a Track 17
- Playing Tracks Repeatedly 18
- Playing Tracks in Random Order (Shuffle Play) 19
- Creating Your Own Program (Program Play) 20
- Listening to a Multi-channel Super Audio CD (Multi-channel management function) 21

Storing Information About CDs 24

- What You Can Do With the Disc Name 24
- Labeling Discs (Disc Name) 24

Additional Information 26

- Using the CONTROL A1II control system 26
- Precautions 27
- Notes on Discs 28
- Troubleshooting 29
- Specifications 29
- Index 30

Getting Started

Before You Start the Hookup

Checking the supplied accessories

This player comes with the following items:

- Audio connecting cord
phono jack × 2 (Red and White) ↔ phono jack × 2 (Red and White) (2)
phono jack × 1 (Black) ↔ phono jack × 1 (Black) (2)
- Monaural (2P) mini-plug cord (1) (Connecting cord for CONTROL A1 II) (supplied for Canadian models only)
- Remote commander (remote) RM-SC500 (1)
- R6 (size-AA) batteries (2)

Inserting batteries into the remote

Insert two R6 (size-AA) batteries into the battery compartment with the + and – correctly oriented to the markings. When using the remote, point it at the remote sensor  on the player.

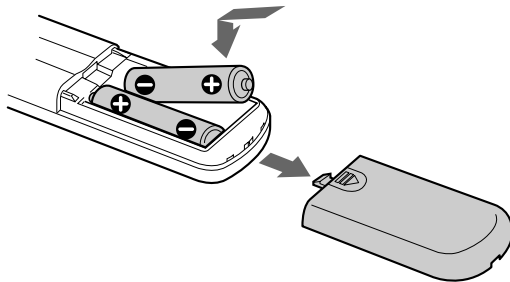

When to replace the batteries

Under normal conditions, the batteries should last for about six months. When the remote no longer operates the player, replace both batteries with new ones.

Notes

- Do not leave the remote in an extremely hot or a humid place.
- Do not drop any foreign object into the remote casing, particularly when replacing the batteries.
- Do not use a new battery with an old one.
- Do not expose the remote sensor to direct sunlight or lighting apparatus. Doing so may cause a malfunction.
- If you do not intend to use the remote for an extended period of time, remove the batteries to avoid possible damage from battery leakage and corrosion.

Hooking Up the Audio Components

Connect the Super Audio CD player to an audio component. Be sure to turn off the power of all components before making connections and connect securely to prevent noise.

When you have an amplifier equipped with the 5.1CH input jacks (multi-channel amplifier, AV amplifier, etc.) and connect the player and the amplifier via ANALOG 5.1CH OUT jacks, you can play a multi-channel Super Audio CD and enjoy the multi-channel playback.

For normal playback, connect the player and an amplifier via ANALOG 2CH OUT jacks.

Connecting via ANALOG 5.1CH OUT jacks

Use audio connecting cords for this connection. Connect the ANALOG 5.1CH OUT jacks (FRONT L/R, SURR L/R, CENTER, SUBWOOFER) to the corresponding jacks of your amplifier. For FRONT or SURR connection, use the connecting cords (Red and White jacks) and be sure to match the colour-coded pin to the appropriate jacks: white (left) to white and red (right) to red. For CENTER and SUB WOOFER connection, use the connecting cords (Black).

FRONT or SURR connection

Audio connecting cords (Red and White) (supplied)

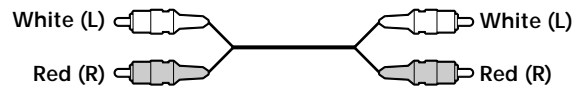

CENTER or SUB WOOFER connection

Audio connecting cords (Black) (supplied)

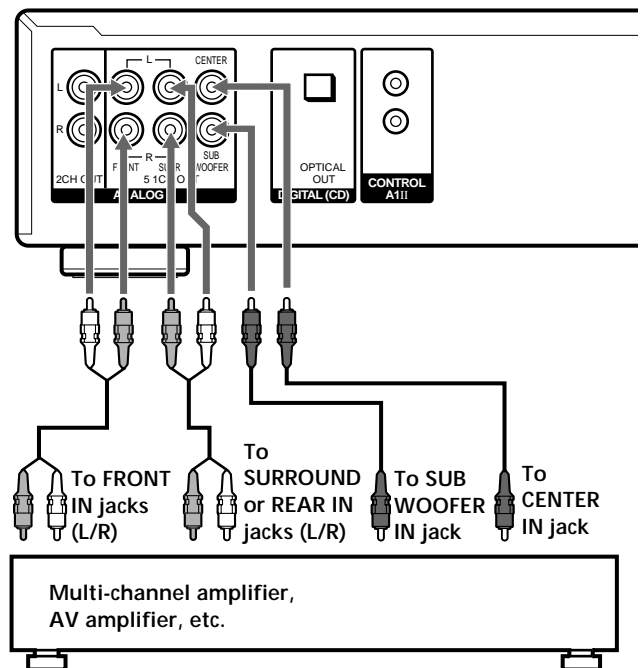

Notes

- When you make the Multi-channel connection, connect the ANALOG 2CH OUT jacks also using another audio connecting cord (not supplied) so that you can play a CD (or SACD) when you set the input selector of your amplifier to CD (or SACD) input .
- During playback of a conventional CD or a 2CH Super Audio CD, the same signal that is output from the ANALOG 2CH OUT jacks is also output from the ANALOG 5.1CH FRONT L/R jacks.
- During playback of a Multi-channel Super Audio CD, the same signal that is output from the ANALOG 5.1CH FRONT L/R jacks is also output from the ANALOG 2CH OUT jacks. (The down mixed signal of the Multi-channel signal is not played back.)
- There are 5CH, 4CH, and 3CH Super Audio CD. When you play these disc, the signal does not output from all the jacks of the ANALOG 5.1CH OUT. For details of the playback, see the cover or instructions of the Super Audio CD.

Connecting via ANALOG 2CH OUT jacks

Use an audio connecting cords for this connection. Connect the ANALOG 2CH OUT L/R jacks to the CD (SACD) input jacks of your amplifier. Be sure to match the color-coded pin to the appropriate jacks: white (left) to white and red (right) to red.

Audio connecting cords (Red and White) (not supplied*)

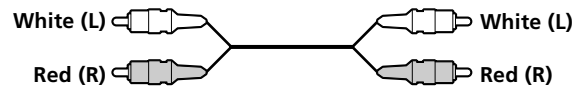

* If you do not make the ANALOG 5.1 CH connection (page 4), you can use the supplied audio connecting cable for the ANALOG 2CH connection.

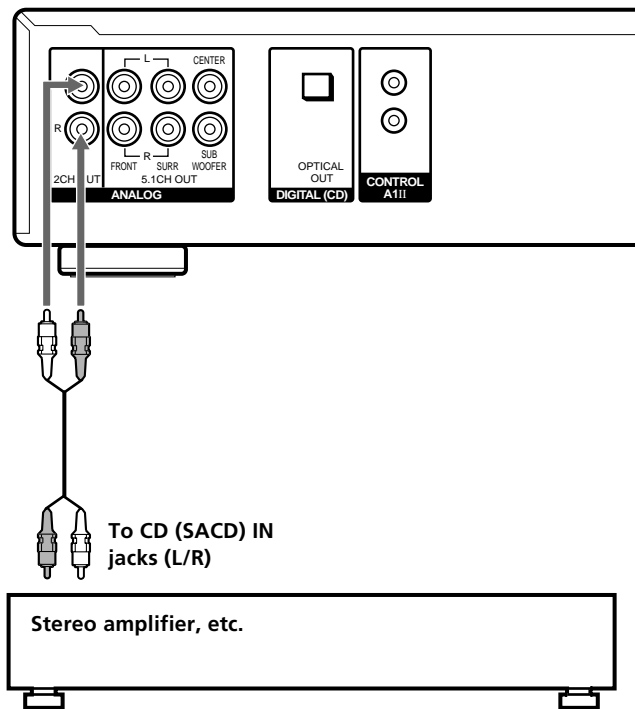

Hooking Up the Audio Components

Connecting via DIGITAL (CD) OUT OPTICAL connector

Use an optical digital cable for this connection. When connecting the optical digital cable to the DIGITAL (CD) OUT OPTICAL connector, take the cap off the connectors and push the cable plugs in until they click into place.

Be careful not to bend or twist the optical cable.

Optical digital cable (not supplied)

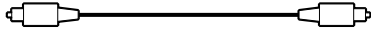

Note

Only the audio signals of conventional CDs can be output from the DIGITAL (CD) OUT connectors. Those of the Super Audio CD cannot be output through DIGITAL (CD) OUT.

Connecting the AC power cord

Connect the AC power cord to a wall outlet.

About the CONTROL A1II jack

If you have a Sony component with the CONTROL A1II (or CONTROL A1) jack

Connect the component via the CONTROL A1II (or CONTROL A1) jack with a monaural (2P) mini-plug cord. You can simplify the operation of audio systems composed of separate Sony components. For details, see "Using the CONTROL A1II Control System" on page 26.

When using another Sony CD player in conjunction with this player

You can set the supplied remote to be effective on this player only by changing the command mode of the remote.

If you connect this player to another Sony CD player, you have to set the command mode of each player.

To set the command mode of the remote

- If the other player's command mode can be set:
Set the CD1/2 switch of this player's remote to CD1 (factory setting), and set the other player's remote to CD2.
- If the other player's command mode cannot be set:
Set the CD1/2 switch of this player's remote to CD2.

To set the command mode of this player

- 1 Press **MENU**.
- 2 Turn **◀◀ AMS ▶▶** to select "COMMAND MODE."
- 3 Push **◀◀ AMS ▶▶**.
The current command mode appears.
- 4 Turn **◀◀ AMS ▶▶** to select CD1 or CD2, then push **◀◀ AMS ▶▶** again.

Transporting the player

Before transporting the player, follow the procedure below to return the internal mechanisms back to their original position.

- 1 Remove all the discs from the disc tray.
- 2 Press **⏏ OPEN/CLOSE** to close the disc tray.
"No Disc" appears in the display.
- 3 Wait for 10 seconds, then press **POWER** to turn off the player.

Location and Functions of Parts

Further details are provided on the pages indicated in parentheses.
It also tells you about the information that appears in the display window.

Front Panel Parts Descriptions

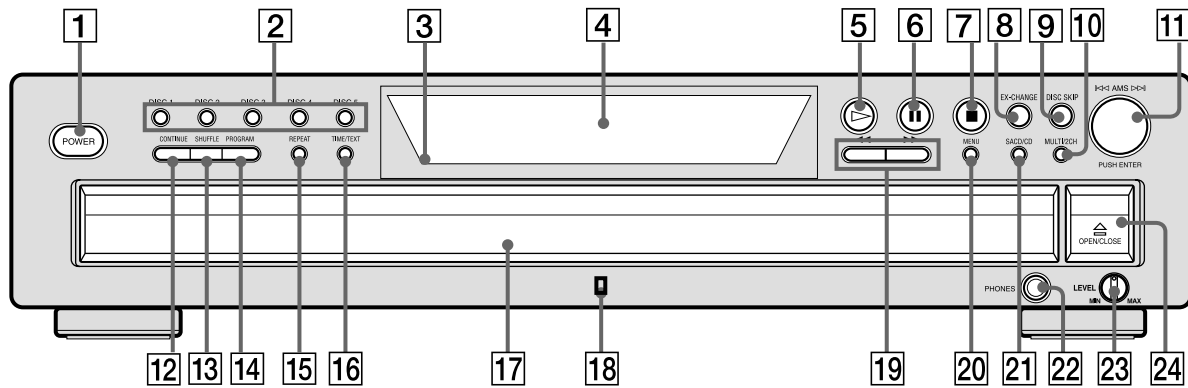

- 1 POWER switch (11)**
Press to turn on/off the player.
- 2 DISC 1-5 button (12)**
Press to select the disc.
- 3 Remote sensor (4)**
- 4 Display window (12)**
Shows various information.
- 5 ► button (12)**
Press to start play.
- 6 || button (12)**
Press to pause play.
- 7 ■ button (12)**
Press to stop play.
- 8 EX-CHANGE button (15)**
Press to replace discs while playing a disc.
- 9 DISC SKIP button (11)**
Press to select the disc.
- 10 MULTI/2CH button (with an LED) (12)**
Press to select the playback area when the 2 channel + Multi-channel Super Audio CD is loaded. When you select the Multi-channel playback area (page 11), the LED turns on.
- 11 ◀◀AMS▶▶ dial (AMS: Automatic Music Sensor) (6, 12)**
When you turn the ◀◀AMS▶▶ dial counterclockwise by one click, you go back to the preceding track; when you turn the ◀◀AMS▶▶ dial clockwise by one click, you go to the succeeding track.
- 12 CONTINUE button (11)**
Press to resume normal play from Shuffle Play or Program Play.
- 13 SHUFFLE button (19)**
Press to select Shuffle Play.
- 14 PROGRAM button (20)**
Press to select Program Play.
- 15 REPEAT button (18)**
Press repeatedly to play all tracks or only one track on the disc.
- 16 TIME/TEXT button (13)**
Each time you press the button, the playing time of the track, the total remaining time on the disc, or TEXT information appears in the display.
- 17 Disc tray (11)**
Press \triangle OPEN/CLOSE to open/close the disc tray.
- 18 MULTI CHANNEL DECODING indicator**
Turns on when you turn on the player, or when the Multi-channel Super Audio CD is loaded and select the Multi-channel playback area by pressing MULTI/2CH.
- 19 ◀◀/▶▶ buttons (17)**
Press to locate a portion you want to play within a track.
- 20 MENU button (6)**
Press to enter the menu.
- 21 SACD/CD button (with an LED) (12)**
Each time you press the button while the Hybrid disc (page 10) is loaded, the layer changes between an HD (SACD) layer (the LED turns on) and CD layer (the LED turns off).
- 22 PHONES jack**
Connect the headphones.
During playback of a Multi-channel Super Audio CD, the same signal that is output from the ANALOG 5.1CH FRONT L/R jacks is output from the PHONES jack.
- 23 PHONES LEVEL control**
Adjust the headphones volume.
- 24 \triangle OPEN/CLOSE button (11)**
Press to open/close the disc tray.

Rear Panel Parts Descriptions

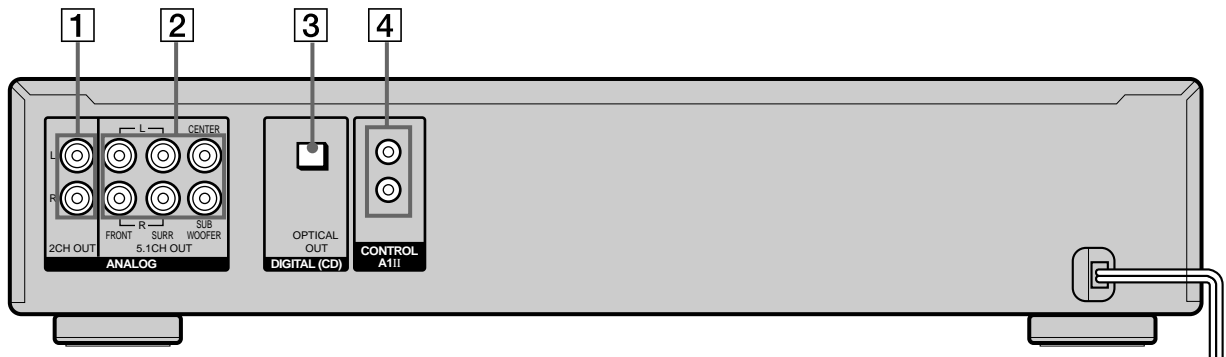

- 1 ANALOG 2CH OUT L/R jacks (5)**
Connect to an audio component (stereo/2 channel) using the audio connecting cord.
- 2 ANALOG 5.1CH OUT jacks (4)**
Connect to an amplifier equipped with the 5.1CH input jacks (Multi-channel amplifier, AV amplifier, etc.) using the audio connecting cords.
- 3 DIGITAL (CD) OUT OPTICAL connector (6)**
Connect to an audio component using an optical digital cable.
- 4 CONTROL A1 II jacks (6, 26)**
Connect to a Sony audio component using the monaural (2P) mini-plug cord.

Note

Only the audio signals of the CD can be output from the DIGITAL (CD) OUT connectors shown in **3**. Those of the Super Audio CD cannot be output through DIGITAL (CD) OUT.

Remote Parts Descriptions

1 CONTINUE button (11)

Press to resume normal play from Shuffle Play or Program Play.

SHUFFLE button (19)

Press to select Shuffle Play.

PROGRAM button (20)

Press to select Program Play.

2 NAME INPUT button (25)

Press to enter the name input mode.

3 DISC/CAPS button (16, 25)

Press to select the disc.

Press to select the capital letter in name input mode.

4 Number buttons (16)

Press to enter the track numbers.

5 >10 button (16)

Press to locate a track numbered over 10.

6 REPEAT button (18)

Press repeatedly to play all tracks or only one track on the disc.

7 CHECK button (20)

Press to check the programmed order.

8 ▷ button (12)

Press to start play.

|| button (12)

Press to pause play.

■ button (12)

Press to stop play.

9 AMS ◀◀/▶▶ (AMS: Automatic Music Sensor) buttons (16)

Press to locate a specific track.

10 ◀◀/▶▶ buttons (17)

Press to locate a portion you want to play within a track.

11 DISC SKIP +/- buttons (16)

Press to select the disc.

12 CD1/2 (COMMAND MODE) switch (6)

Select the command mode.

13 DISPLAY MODE button (13)

Press to turn off the information.

14 SACD/CD button (12)

Each time you press the button while the Hybrid disc (page 10) is loaded, the layer changes between an HD layer (the SACD/CD LED turns on) and CD layer (the SACD/CD LED turns off).

15 MULTI/2CH button (12)

Press to select the playback area when the 2 channel + Multi-channel Super Audio CD is loaded. When you select the Multi-channel playback area (page 11), the MULTI/2CH LED turns on.

16 TIME/TEXT/SPACE button (13, 25)

Each time you press the button, the playing time of the track, the total remaining time on the disc, or TEXT information appears in the display.

Press to insert a space in name input mode.

17 ENTER button (25)

Press to decide the selection.

18 CLEAR button (20)

Press to delete a programmed track number.

19 LEVEL ADJ button (23)

Press to adjust the output level balance for the Multi-channel management function (page 24).

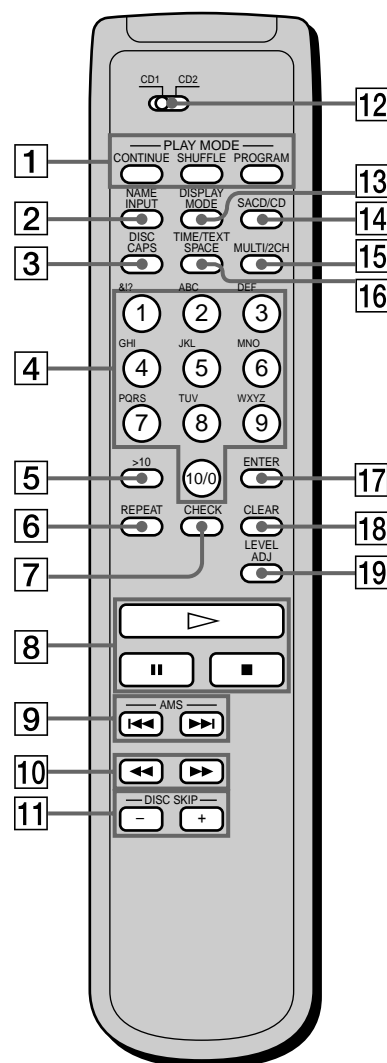

Playing Discs

Compatible Disc Types

You can play the following discs with this player. Depending on the type of disc to be played, select the appropriate indicator by pressing SACD/CD or MULTI/2CH (pages 12).

Classification by the layer configuration

Super Audio CD (single layer disc)

This disc consists of a single HD (high density) layer. When you play this disc, the player is set to the Super Audio CD playback mode automatically.

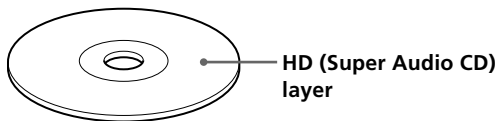

Super Audio CD (dual layer disc)

This disc consists of dual HD (high density) layers and is capable of extended play over long periods. When you play this disc, the player is set to the Super Audio CD playback mode automatically. Also, as the dual layer disc consists of dual HD layers on one side only, it is not necessary to turn the disc over.

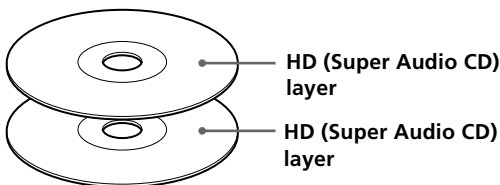

Conventional CD

This disc is the standard format. When you play this disc, the player is set to the Conventional CD playback mode automatically.

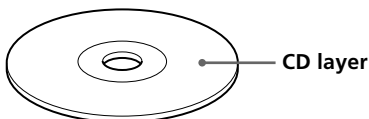

Super Audio CD + CD (Hybrid disc)

This disc consists of an HD layer and a CD layer. Press SACD/CD to select the layer you want to listen to. Also, as the dual layers are on one side, it is not necessary to turn the disc over. You can play the CD layer using a conventional CD player.

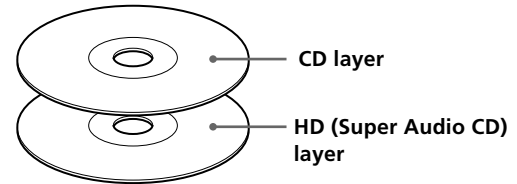

You can select the default playback layer (HD or CD).

- 1 During stop mode, press MENU.
- 2 Turn $\lll \text{AMS} \ggg$ to until "LAYER SELECT" appears in the display.
- 3 Press $\lll \text{AMS} \ggg$.
The current default layer appears.
- 4 Turn $\lll \text{AMS} \ggg$ to select CD or SACD, then push $\lll \text{AMS} \ggg$ again.
The default layer setting is SACD.

Classification by the channel configuration of the Super Audio CD

2 channel Super Audio CD

This disc consists of the 2 channel playback area. When you play this disc, the player is set to the 2 channel playback mode automatically.

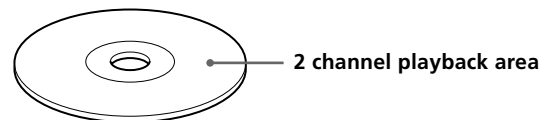

Multi-channel Super Audio CD

This disc consists of the multi-channel playback area. When you play this disc, the player is set to the multi-channel playback mode automatically.



Playing a Disc

The operations for normal play and the basic operations during play are explained below.

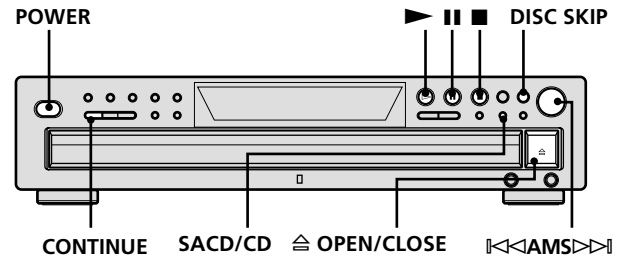

2 channel + Multi-channel Super Audio CD

This disc consists of the 2 channel playback area and the multi-channel playback area.

Press MULTI/2CH to select the playback area you want to listen to.

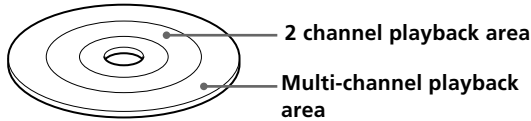

You can select the default playback area (2 channel playback or multi-channel playback area).

- 1 During stop mode, press MENU.
- 2 Turn ◀◀ AMS ▶▶ to until "M/2CH SELECT" appears in the display.
- 3 Press ◀◌ AMS ▶▶. The current playback area appears.
- 4 Turn ◀◌ AMS ▶▶ to select desired playback area, then press ◀◌ AMS ▶▶.

Incompatible Discs

This player cannot play the following discs. If you try to play them, the error message "TOC Error" or "No Disc" will appear or there will be no sound.

- CD-ROM
- DVD, etc.

- 1 Turn on the amplifier. Turn down the volume level to the lowest.
- 2 Select the player position using the input selector on the amplifier.
- 3 Press POWER to turn on the player.
- 4 Press ◌ OPEN/CLOSE to open the disc tray, and place a disc on the tray.

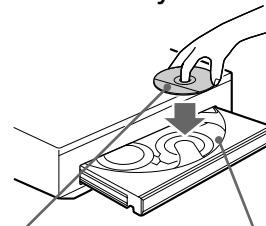

With the label side up Disc number

- 5 To place other discs, press DISC SKIP and place the discs in the order you want to play. Each time you press the button, the disc tray turns and you can place the discs in the empty disc compartments. The player plays the disc in front of you first.
- 6 Press CONTINUE to select ALL DISCS or 1 DISC Continuous Play mode. Each time you press the CONTINUE button, "ALL DISCS" or "1 DISC" appears in the display.

When you select	The player plays
ALL DISCS	All discs in the player consecutively in the order of disc number
1 DISC	Only the disc you've selected

Playing a Disc

7 Press ►.

Playback starts from the first track. If you want to start playing from a specific track, turn ◀◀AMS▶▶ to select the track number before pressing ►.

8 Adjust the volume on the amplifier.

Basic operations during play

To	Press
Stop play	■
Pause play	⏸
Resume play after pausing	⏸ or ►
Locate a succeeding track	Turn ◀◀AMS▶▶ clockwise
Locate the beginning of the current track or a preceding track	Turn ◀◀AMS▶▶ counterclockwise
Go to the next disc	DISC SKIP
Select a disc directly	DISC 1-5
Eject the disc	⏏ OPEN/CLOSE

💡 You can select the disc you want to start playing first. Press one of the DISC 1-5 buttons.

💡 To select a layer you want to listen to when playing a hybrid disc (page 10) After you stop play using ■, press SACD/CD repeatedly to light either "SACD" or "CD".

💡 To select a playback area you want to listen to when playing a 2 channel + Multi-channel Super Audio CD (page 11) After you stop play using ■, press MULTI/2CH repeatedly to light either "MULTI CH" or "2 CH."

Note

During playback, increase the volume level gradually starting from the lowest level. The output from this unit may contain band width that are out of the normal listening range. This may cause damage to the speakers or ears.

Using the Display

The display window shows various information about the disc or track being played. This section describes the current disc information and information that appears for each play status.

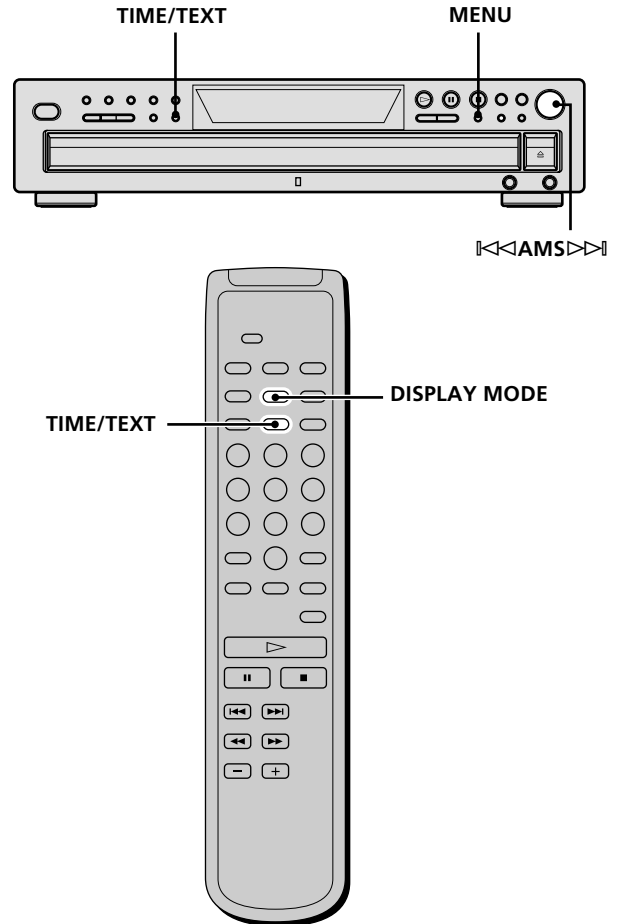

Disc information when a disc is loaded

Depending on the disc that is currently loaded, the display shows as follows:

2 channel Super Audio CD

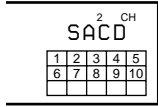

Multi-channel Super Audio CD

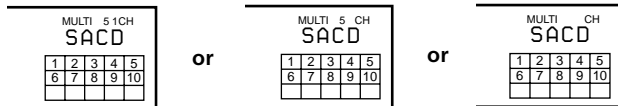

During playback a 5.1 channel Super Audio CD

During playback a 5 channel Super Audio CD

During playback other Super Audio CDs or during stop mode

Conventional CD

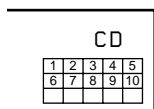

Displaying information while the player is stopped

Press **TIME/TEXT**.

The display shows the current disc number, total number of tracks, and total playing time.

Current disc number Total playing time

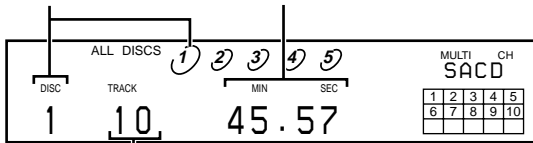

Total number of tracks

The information also appears when you press the \equiv OPEN/CLOSE button to close the disc tray. The tracks numbered over 16 cannot be displayed in the music calendar.

Notes on the disc number indications

- The red circle around a disc number indicates the disc is ready to be played.
- When all the tracks on a disc have been played, the semi-circle around the disc number disappears.
- When a disc compartment is recognized as empty, the semi-circled disc number disappears.

Displaying information while the player is playing

Press **TIME/TEXT**.

Each time you press the button, the current track number and its elapsed time or remaining time appears, or the total remaining time for the disc appears in the display. When the player detects a Multi-channel Super Audio CD, the channel information appears before the default display appears.

Playing track number and elapsed playing time of the current track (default display)

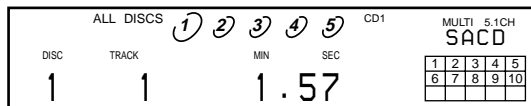

Press **TIME/TEXT**



Playing track number and remaining time of the current track

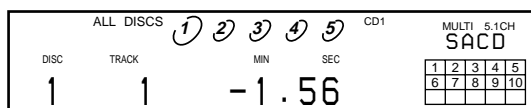

Press **TIME/TEXT**



Total remaining time on the disc

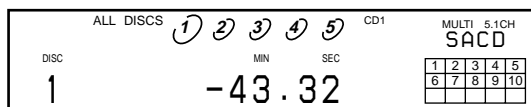

Press **TIME/TEXT**



Channel information (appears only when the player detects a Multi-channel Super Audio CD)

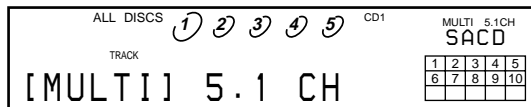

Turning off the information in the display

Each time you press **DISPLAY MODE** on the remote while playing a disc, the display turns off and on alternately. Even when the display is turned off, the display turns on if you pause or stop play. When you resume play, the display turns off again.

Before you start playing, when you press **DISPLAY MODE** to turn off the display, "Display Off" appears, and when you press the button to turn on the display, "Display On" appears.

Using the Display

Displaying the information of a TEXT disc



TEXT discs contain information, such as the disc name or artist name, as well as the audio signals. This player can display the disc name, artist name, and current track name as TEXT information.

When the player detects a TEXT disc, "TEXT" appears in the display.

Displaying the information of a TEXT disc in stop mode



Press TIME/TEXT.

Each time you press the button, the disc name or artist name appears in the display. When you select the artist name, "ART" appears in the display.

- Before you start playing

Disc title

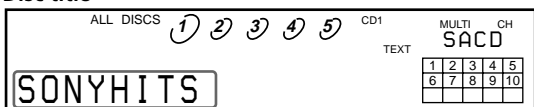

Press TIME/TEXT



Artist name

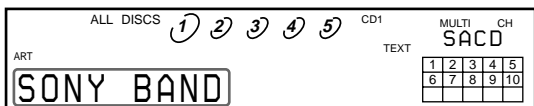

Press TIME/TEXT



Total number of tracks and total playing time

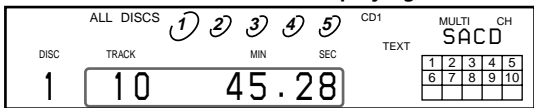

Press TIME/TEXT

Display information of a TEXT disc while playing a disc



The current track name appears. If the disc name has more than 15 characters, the first 14 characters will remain after the name scrolls by in the display.

When the player detects a Multi-channel Super Audio CD, the channel information appears before the playing time of the current track appears.

- While playing a disc

Track title

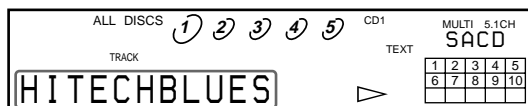

Press TIME/TEXT



Channel information (appears only when the player detects a Multi-channel Super Audio CD)

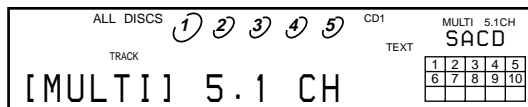

Playing time of the current track

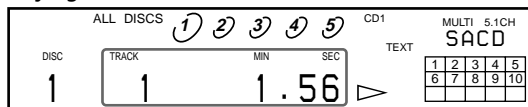

Press TIME/TEXT



Remaining time on the current track

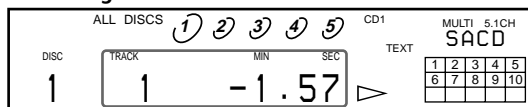

Press TIME/TEXT



Remaining time on the disc

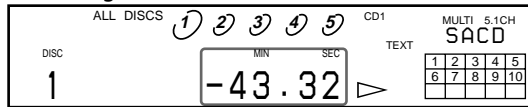

Press TIME/TEXT

Notes

- The display may not show all the characters, depending on the disc.
- This player can display only the disc name, artist name, and track names from TEXT discs. Other information cannot be displayed.

Displaying the information of a TEXT disc in other languages

You can change the displayed language if the TEXT disc has multi language capacity. When the player detects such a TEXT disc, "TEXT" and "MULTI" appear in the display. Change the language according to the procedures below.

- 1 Press **MENU** in stop mode.
- 2 Turn **◀◀ AMS ▶▶** until "LANGUAGE" appears in the display.
- 3 Press **◀◀ AMS ▶▶**.
The current selected language (English, French, German, etc.) flashes.
If the player cannot display the language used in a TEXT disc, "Other Lang" appears in the display.
- 4 Turn **◀◀ AMS ▶▶** until the desired language appears in the display.
- 5 Press **◀◀ AMS ▶▶**.
After a few seconds, the information appears in the selected language.

Replacing Discs While Playing a Disc

You can open the disc tray while playing a disc so that you can check what discs are to be played next and replace discs without interrupting play of the current disc.

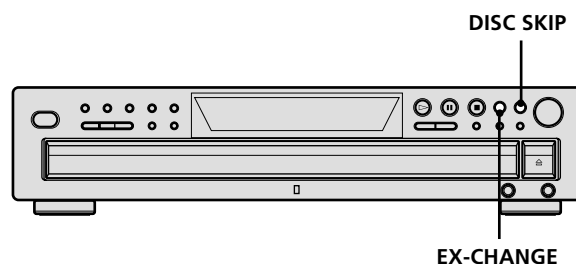

- 1 Press **EX-CHANGE**.
The disc tray opens and two disc compartments appear. Even if the player is playing a disc, it doesn't stop playing.
- 2 Replace discs in the compartments with new ones.
The player plays the disc on the left side compartment after the current disc, and then the one on the right side compartment.
- 3 Press **DISC SKIP**.
The disc tray turns and other two disc compartments appear.
- 4 Replace discs in the compartments with new ones.
- 5 Press **EX-CHANGE**.
The disc tray closes.

Note

Do not push the disc tray to close it in Step 5, as you may damage the player.

While the disc tray is open by pressing the EX-CHANGE button

- If the play of the current disc ends, the player stops playing. If the disc is played in 1 DISC Repeat Play mode (see page 18), the current disc starts playing again.
- In ALL DISCS Shuffle Play mode (see page 19), tracks are reshuffled on the current disc.
- In Program Play mode (see page 20), only the tracks on the current disc are played.

Locating a Specific Disc

You can locate any disc before or while playing a disc.

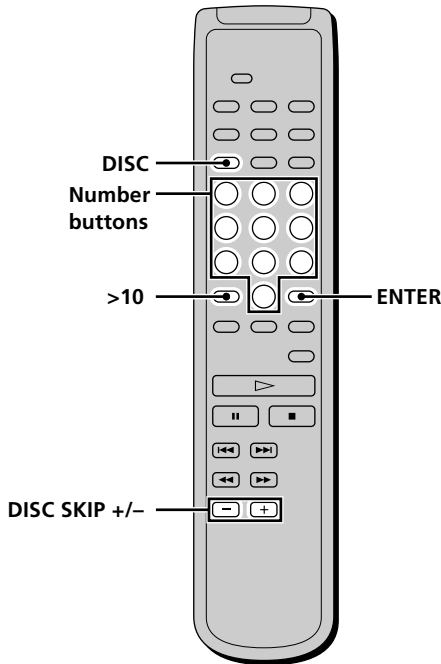
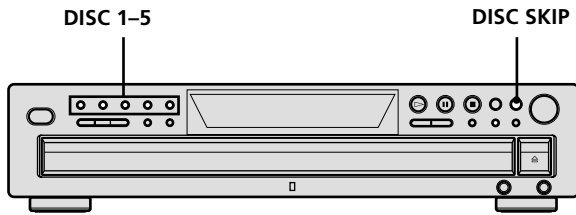

To locate	Press
The next disc	DISC SKIP while playing a disc
The next or succeeding discs	DISC SKIP + repeatedly until you find the disc
The current or preceding discs	DISC SKIP - repeatedly until you find the disc
A specific disc directly	DISC 1-5. When using the remote, follow the procedure below.
	<ol style="list-style-type: none"> 1 Press DISC. 2 Press the number button of the disc. 3 Press ENTER.

Locating a Specific Track

During stop or play mode, you can locate any track to be played.

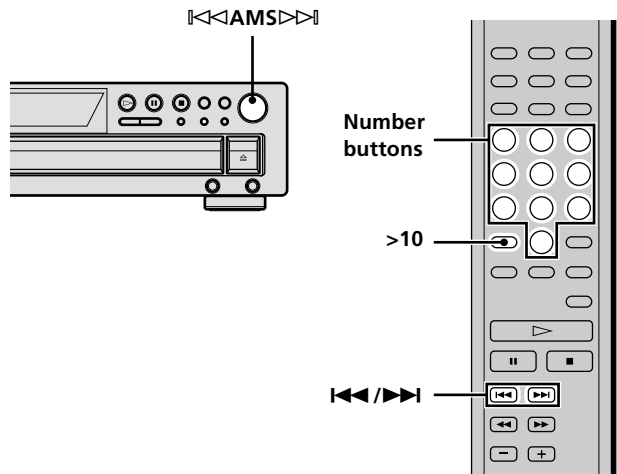

To locate	You need to
The next or succeeding tracks	Turn AMS clockwise until you find the track. When using the remote, press ▶▶ repeatedly until you find the track.
The current or preceding tracks	Turn AMS counterclockwise until you find the track. When using the remote, press ◀◀ repeatedly until you find the track.
A specific track directly	Turn AMS until you find the track number you want. When using the remote, press ◀◀ or ▶▶ repeatedly until you find the track.

Locating a track directly by entering the track number

Press the number button(s) to enter the track number.

To enter a track number over 11

1 Press >10.

2 Enter the corresponding digits.

To enter 0, press 10/0 instead.

Examples:

- To play track number 30, press >10, then 3 and 10/0.
- To play track number 100, press >10 twice, then 1, and 10/0 twice.

Locating a Particular Point in a Track

You can locate a particular point in a track during play or play pause.

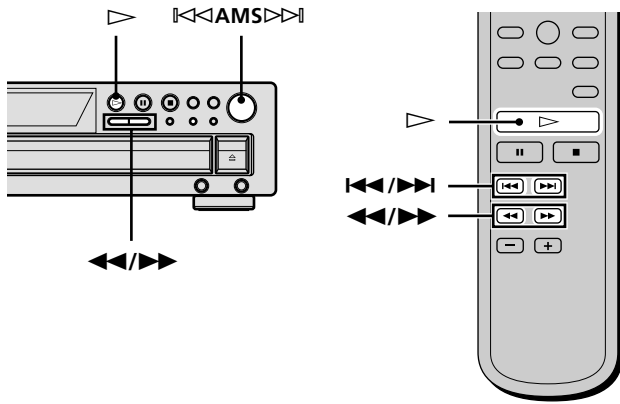

Locating a point while monitoring the sound (Search)

Press and hold ◀▶/▶▶ during play.

You will hear intermittent playback as the disc goes forward or reverses.

When you reach the desired point, release the button.

Locating a point by observing the time indication (High-Speed Search)

Press and hold ▶▶/▶▶ during play pause.

You will not hear the playback sound.

💡 When "Over!!" appears in the display

The disc has reached its end. Press ◀◀ or ▶▶ to go back.

Note

Tracks that are only a few seconds long may be too short for monitoring. In this case, the player may not search correctly.

Locating a point by setting the start time (Time Search)

- 1 Turn ◀◀ AMS ▶▶ or press ▶▶/▶▶ to select the desired track in stop mode.
- 2 Press and hold ▶▶/▶▶ to set the time to start play while looking at the display.

You can set the time from the beginning of the desired a track when you press ▶▶ at first, and set the time from the end of the desired track backward's when you press ▶▶ at first.

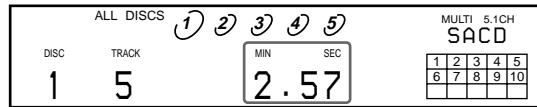

- 3 Press ▶▶.

Play will start at the time search.

Playing Tracks Repeatedly

You can play an entire disc or portions thereof repeatedly. This function can be used with Shuffle Play to repeat all the tracks in random order (page 19), or with Program Play to repeat all the tracks in a program (page 20).

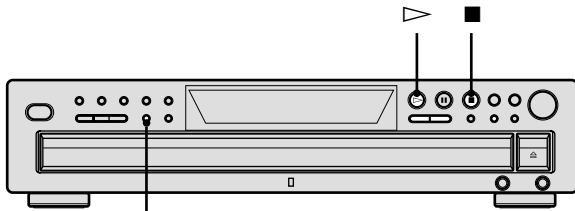

REPEAT

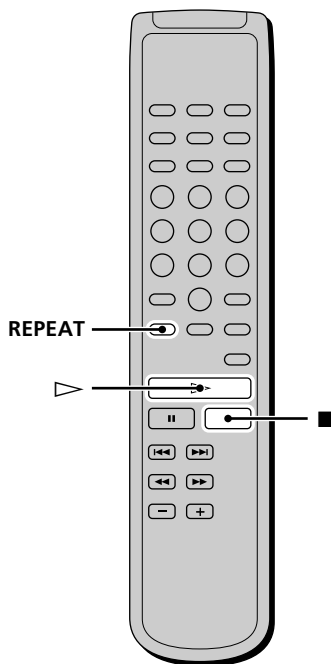

REPEAT

Note

If you turn off the player or disconnect the power cord, the player will store the last setting of repeat play ("REPEAT" or "REPEAT 1") and recall it the next time you turn on the player.

Repeating all the tracks on the disc (Repeat All Play)

Press **REPEAT** once, then press **▷**.

"REPEAT" appears in the display and Repeat All Play starts.

The repeat play changes depending on the play mode you select.

When the play mode is	The player repeats
ALL DISCS Continuous Play (page 11)	All the tracks on all discs
1 DISC Continuous Play (page 11)	All the tracks on the current disc
ALL DISCS Shuffle Play (page 19)	All the tracks on all discs in random orders
1 DISC Shuffle Play (page 19)	All the tracks on the current disc in random orders
Program Play (page 20)	All the tracks in the program in sequence

To stop Repeat All Play

Press **■**.

To resume normal play

Press **REPEAT** repeatedly until "REPEAT" goes off.

Repeating the current track (Repeat 1 Play)

While the track you want to repeat is being played, press **REPEAT** repeatedly until "REPEAT 1" appears in the display.

Repeat 1 Play starts.

To stop Repeat 1 Play

Press **■**.

To resume normal play

Press **REPEAT** repeatedly until "REPEAT 1" goes off.

Playing Tracks in Random Order (Shuffle Play)

You can have the player “shuffle” tracks and play in a random order. The player shuffles all the tracks on all discs or one disc you’ve specified.

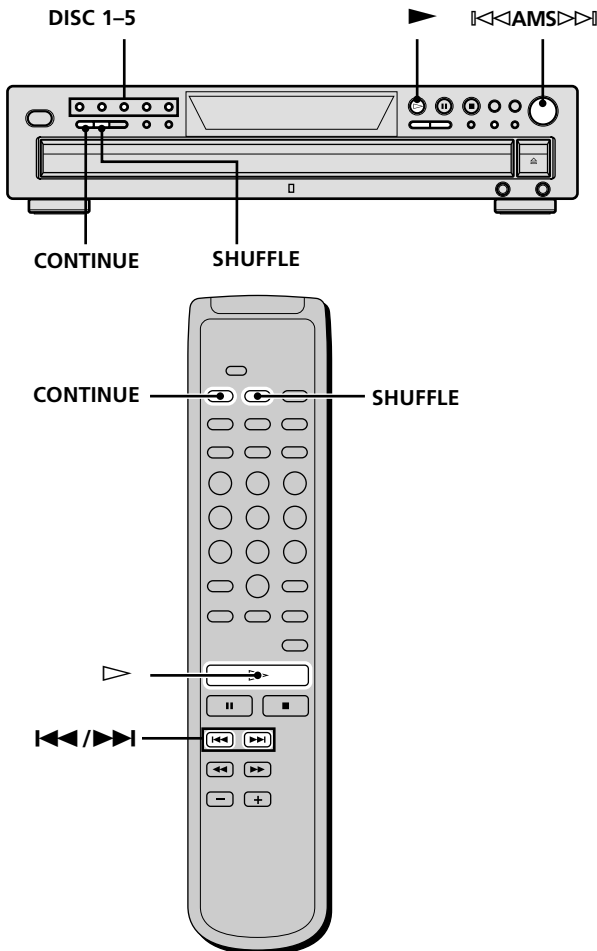

Shuffle Play on one disc

You can play all tracks on the specific disc in a random order.

- 1 Press **SHUFFLE** repeatedly until “1 DISC” appears in the display.
- 2 Press **DISC 1-5** to start 1 DISC Shuffle Play on the selected disc.
“AMS” appears while the player is “shuffling” the tracks. The player will stop after playing all the tracks once.

To resume normal play

Press **CONTINUE**.

💡 You can locate tracks during Shuffle Play

Turn **AMS** or press **AMS**.

The player does not go back to tracks which have already been played.

💡 You can start Shuffle Play while playing

Press **SHUFFLE**, and Shuffle Play starts from the current track.

Shuffle Play on all discs

You can play all tracks on all discs in a random order.

- 1 Press **SHUFFLE** repeatedly until “ALL DISCS” appears in the display.
- 2 Press **AMS** to start ALL DISCS Shuffle Play.
“AMS” appears while the player is “shuffling” the tracks. The player will stop after playing all the tracks once.

Creating Your Own Program (Program Play)

You can pick out the tracks that you like and specify the playback order in a program containing up to 32 tracks.

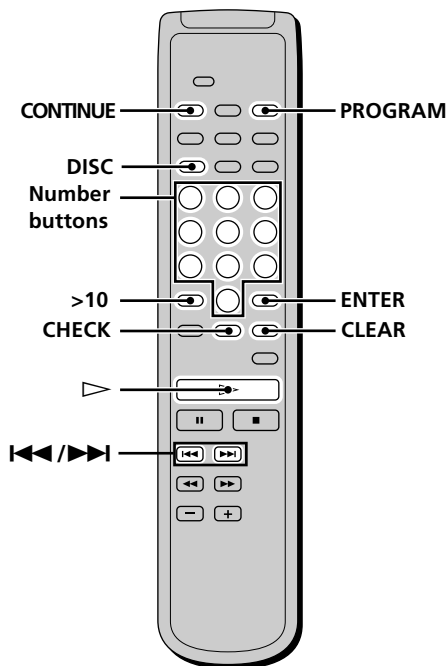

Playing Discs

- 1 Press PROGRAM in stop mode.**
"PROGRAM" appears in the display.
- 2 Press DISC.**
Cursor flashes in the display.
- 3 Press the number button of the disc.**
The selected disc number appears in the display.
- 4 Press ENTER.**
When you want to program the whole disc as one step, skip Steps 5 to 6, and go to Step 7.
- 5 Press the number buttons to enter the track number.**
If you entered the wrong track number
Press CLEAR to erase the track number and reenter the correct track number using the number buttons.
To select a track number over 11
Press >10 (page 16).
- 6 Press ENTER.**
- 7 Repeat steps 2 to 6 to enter other tracks.**
Each time you enter a disc or track number, the total program time appears in the display.
- 8 Press ▷.**
Program Play starts.

To resume normal play

Press CONTINUE.

💡 You can create your program while checking the disc labels
While the disc tray is open, follow Steps 1 to 8 with pressing the DISC SKIP button to check the disc labels.

Note that, if the programmed track number isn't found on the disc, that step is automatically erased.

💡 The program remains even after Program Play ends
Press ▷ to play from the beginning of the program again. The program remains even if you stop play.

💡 The program remains until you erase it
If you replace discs, the programmed disc and track numbers remain. So, the player plays only the existing disc and track numbers. However, the disc and track numbers that aren't found in the player or on the disc are deleted from the program, and the rest of the program is played in the programmed order.

Note

If you turn off the player, disconnect the power cord, or press ≡ OPEN/CLOSE the program will be erased.

Checking the contents of the program

Before you start playing or while the player is playing, press CHECK.

Each time you press the button, the track numbers will appear in the display in the programmed order. When you press CHECK while the player is playing, the track number appears from the next track numbers of the current playing track number.

Changing the contents of the program

You can change the contents of the program in stop mode.

To	Do the following:
Erase a track	<ol style="list-style-type: none"> 1 Press CHECK repeatedly until the track number you want to erase appears. 2 Press CLEAR.
Erase from the last track in the program	Press CLEAR. Each time you press the button, the last track of the program is erased.
Add a track to the end of the program	Press DISC SKIP +/- and ◀▶ to select the track you want to add, then press PROGRAM. When using the remote, press the number button of the track to be added.
Erase all tracks	Hold down CLEAR until "Prog CLEAR" appears in the display.

Listening to a Multi-channel Super Audio CD

(Multi-channel management function)

This player is equipped with a Multi-channel management function that sets the playback mode of the Super Audio CD by the DSD-DSP (built into the player) according to the layout or size of your speaker.

Example of the speaker layout

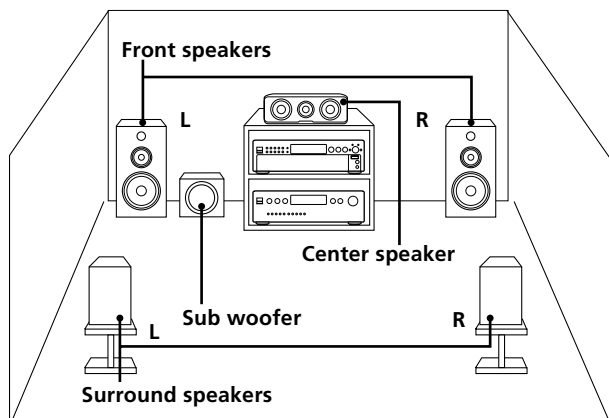

To set the Multi-channel management:

- 1 Select the appropriate preset playback mode (2 channel playback or Multi-channel playback).
- 2 Adjust the output level balance of each speaker (only when you select the Multi-channel playback mode).

Notes

- This features only work when you play the Super Audio CD.
- You may not be able to adjust the output level balance depending on the speaker layout mode that you selected.

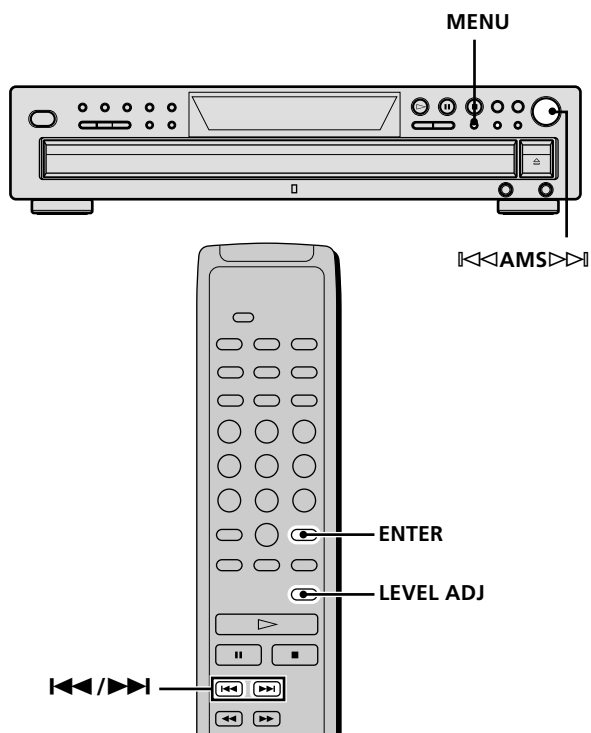

Selecting 2 channel playback mode

- 1 Press MENU.
- 2 Turn **AMS** until "2CH SPK MODE" appears in the display.
- 3 Press **AMS**.
The playback mode appears in the display.

Playback mode	Front speakers	Sub woofer
2CH Direct	Each signal outputs directly from front speakers. No signal outputs from the Sub woofer.	
2CH + SW	○	○

- 4 Turn **AMS** until desired mode appears in the display.
- 5 Press **AMS**.

Note

You cannot operate this function when the player is in the CD or Multi-channel playback mode. Operate this function when the player is in the 2 channel Super Audio CD playback mode, the disc tray is opened, or no discs are in the player.

Selecting Multi-channel playback mode

- 1 Press MENU.
- 2 Turn **AMS** until "MCH SPK MODE" appears in the display.
- 3 Press **AMS**.
The playback mode appears in the display.

Playback mode	Front speakers	Center speaker	Surround speakers	Sub woofer
MCH Direct	Each signal outputs directly from each speaker.			
5 - Large + SW	Large	Large	Large	○
5 - Large	Large	Large	Large	—
5 - Small + SW	Small	Small	Small	○
FRT - Large + SW	Large	Small	Small	○
FRT - Large	Large	Small	Small	—
No - CNTR + SW	Large	—	Large	○
No - CNTR	Large	—	Large	—

About "Large" or "Small" speaker

A "Large" speaker is a speaker that can reproduce bass frequencies plentifully. If you select "Small" for the surround speakers, the bass frequencies will come from the front speakers and/or sub woofer.

For normal use, select "MCH Direct" or set all the speakers to "Large" (ex. "5 - Large + SW," "5 - Large," etc.). If the sound is noisy or the Multi-channel playback is not effective while playing a Multi-channel Super Audio CD, change the settings of the speakers concerned to "Small."

4 Turn **◀◀ AMS ▶▶** **until desired mode appears in the display.**

5 Press **◀◀ AMS ▶▶**.

The output level balance setting display appears.

To set the output level balance, go to Step 4 in "Adjusting the output level balance on the front panel of the player" on page 22 or Step 2 in "Adjusting the output level from the remote" on page 23.

To return to the normal display, press MENU.

Notes

- The Multi-channel management function does not work when you select "MCH Direct" (you cannot set the output level balance of each speaker).
- The front speaker setting is set to "Large" automatically when you set the Sub woofer to "—."
- When you play a track that does not contain the LFE* signal, the signal for the Sub woofer does not output. Therefore, when you select "MCH Direct," "5 - Large + SW," or "No - CNTR + SW," no signal outputs from the Sub woofer. However, when you select "5 - Small + SW" or "FRT - Large + SW" (when you set the speaker setting to "Small"), the bass frequencies will come from the sub woofer.

* Low Frequency Enhancement (described as ".1 CH")

Adjusting the output level balance of each speaker

You can adjust following items with the Multi-channel management function:

CNTR BALANCE

The relative output level balance between the front speakers (FRONT L/R) and the center speaker (CENTER)

SURR BALANCE

The relative output level balance between the front speakers (FRONT L/R) and the surround speakers (SURR L/R)

SW BALANCE

The relative output level balance between the front speakers (FRONT L/R) and the sub woofer (SUB WOOFER)

Note

Some adjustment may not work depending on the Multi-channel playback mode that you selected.

Adjusting the output level balance on the front panel of the player

You can adjust the output level balance of each speaker while listening during playback. You can also adjust while listening to the test tone during stop mode.

1 Press MENU.

2 Turn **◀◀ AMS ▶▶** **until "LEVEL ADJUST" appears in the display.**

3 Press **◀◀ AMS ▶▶**.

During playback, go to Step 6.

4 Turn **◀◀ AMS ▶▶** **until "TONE ON" appears in the display.**

5 Press **◀◀ AMS ▶▶**.

The test tone issues from the speakers in sequence with the speaker type appearing in the display.

6 Turn **◀◀ AMS ▶▶** **until the desired item appears in the display.**

Select the item from "CNTR BALANCE," "SURR BALANCE," or "SW BALANCE."

Note

When you set the Sub woofer to "—" in the Multi-channel playback mode (page 21), "SW BALANCE" does not appear. Similarly, "CNTR BALANCE" or "SURR BALANCE" does not appear when you set the corresponding speaker to "—."

7 Press **◀◀ AMS ▶▶**.

The balance adjustment display appears.
In stop mode, the test tone is output from the selected speaker.

Example: When you select “SURR BALANCE” during stop mode, the test tone is output from the front speakers and surround speakers.

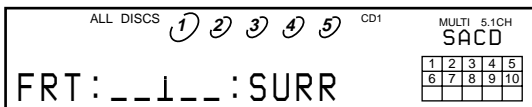

8 Turn **◀◀ AMS ▶▶** to adjust the output level.

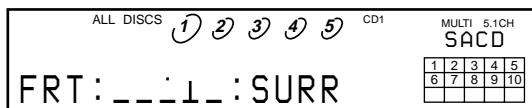

9 Press **◀◀ AMS ▶▶**.

The player status returns to Step 6.
Repeat Step 6 through 9 for more adjustments.

10 Press MENU after you finish adjusting.

The display returns to the normal display.

Adjusting the output level from the remote

You can adjust the output level of each speaker from the listening position by using the supplied remote.

1 Press LEVEL ADJ during playback or stop mode.

During playback, go to Step 4.

2 Press **◀◀/▶▶** repeatedly until “TONE ON” appears in the display.

3 Press ENTER.

The test tone issues from the speakers in sequence with the speaker type appearing in the display.

4 Press **◀◀/▶▶** repeatedly until the desired item appears in the display.

Select the item from “CNTR BALANCE,” “SURR BALANCE,” or “SW BALANCE.”

Note

When you set the Sub woofer to “—” in the Multi-channel playback mode (page 21), “SW BALANCE” does not appear. Similarly, “CNTR BALANCE” or “SURR BALANCE” does not appear when you set the corresponding speaker to “—.”

5 Press ENTER.

The balance adjustment display appears.
In stop mode, the test tone is output from the selected speaker.

Example: When you select “SURR BALANCE” during stop mode, the test tone is output from the front speakers and surround speakers.

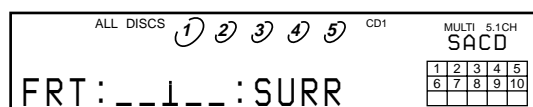

6 Press **◀◀/▶▶** repeatedly to adjust the output level.

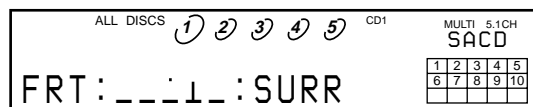

7 Press ENTER.

The player status returns to Step 4.
Repeat Step 4 through 7 for more adjustments.

8 Press LEVEL ADJ after you finish adjusting.

The display returns to the normal display.

Storing Information About CDs

What You Can Do With the Disc Name

The player can store the information called "Disc Name," up to 255 discs (for the Hybrid disc, each layer is correspond to the Disc Name). Once you have stored the Disc Name for a disc, the player automatically recalls what you have stored whenever you select that disc.

You can store this information:

When you use	You can
Disc Name (page 24)	Label discs using up to 14 characters

Where is the Disc Name stored?

The Disc Name is stored not on the disc, but in the player's memory. It means you cannot use the Disc Name when you play the disc on other players.

Erasing all Disc Names of all discs

Turn off the player. While holding down ■, press POWER to turn on the player. "ALL ERASE" appears in the display, and all Disc Names will be erased.

Labeling Discs (Disc Name)

You can label discs using up to 14 characters and have the player display the Disc Name each time you select the disc. The Disc Name can be anything you like, such as a title, musician's name, category or date of purchase.



 When you select a TEXT disc

The disc title is stored as the Disc Name automatically. In this case, it is not counted as the stored Disc Name (up to 255 discs). If the disc title has more than 15 characters, the first 14 characters of the disc title are stored (see page 14).

Note that you cannot change the Disc Name of the TEXT disc.

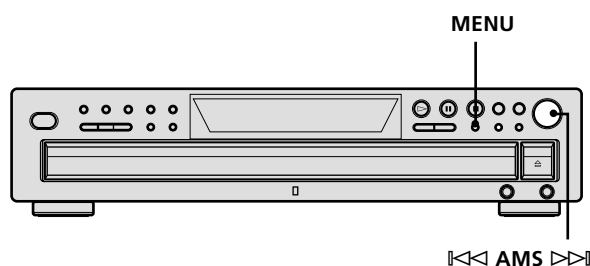
Labeling discs on the player

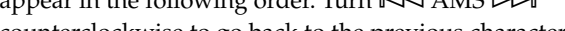

- 1 Insert or select the disc.**
- 2 Press MENU.**
"DISC NAME" appears in the display.
- 3 Push .**
"NAME INPUT" appears, then the flashing cursor appears.
- 4 Turn  until the character you want appears in the display.**
The first space for the Disc Name flashes.
As you turn  clockwise, the characters appear in the following order. Turn  counterclockwise to go back to the previous character.

(space) A B C D E F G H I J K L M N O P Q R S T U V
W X Y Z a b c d e f g h i j k l m n o p q r s t u v w x y z
0 1 2 3 4 5 6 7 8 9 ! " # \$ % & ' () * + , - . / : ; < = > ? @ [\] ^ _ { | } ~
- 5 Push  to select the character.**
The selected character lights up, and the flashing cursor appears to indicate the next space to be input.
- 6 Repeat Steps 4 and 5 to input more characters.**
- 7 Press MENU to store the Disc Name.**
Repeat Steps 1 to 7 to assign Disc Names to other discs.

Labeling Discs Using the Remote

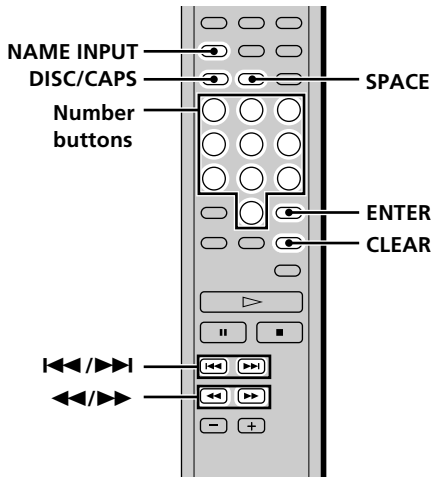

- 1 Press DISC in Continuous Play Mode.**
- 2 Press the number button of the disc you want to assign a Disc Name, and then ENTER.**
- 3 Press NAME INPUT.**
The flashing cursor appears.
- 4 Press CAPS to find the letter type you want.**
Each time you press the button, the letter type changes cyclically among capital letters (ABC), small letters (abc) and numbers (123). To select a symbol, you have to select the capital or small letter type.
- 5 Press the number button to input letters.**
To input a letter, press the number button corresponding to the letter you want (indicated beside each number button).
Each time you press the button, the letter changes cyclically among the ones indicated beside the button. To input symbols, press the number button 1 repeatedly until the symbol you want appears in the display.

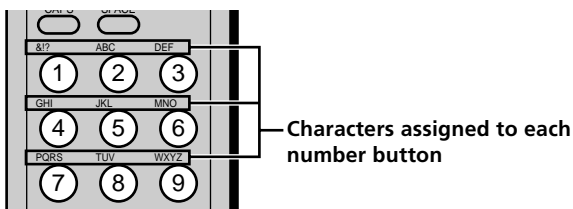

Example: To select the letter E
Press the number button 3 twice.

→ D → E → F →

Press 3. Press 3.

Press 3.

To insert a space, press SPACE once.
To input a number, press the number button you want.

- 6 Press >>> to select the character.**
The selected character lights up, and the flashing cursor appears to indicate the next space to be input. You can also go to the next space by pressing other number buttons.
- 7 Repeat Steps 4 through 6 to input more characters.**
- 8 Press NAME INPUT to store the Disc Name.**
Repeat Steps 1 through 8 to assign Disc Names to other discs.

 **If you have made a mistake while inputting the character**

- To correct the character which has been input
- 1 Press <<< or >>> until the incorrect character flashes.
 - 2 Press <<<< or >>>> until the desired character appears.

- To correct the character currently being input
- 1 Press CLEAR to delete the incorrect character.
 - 2 Input the correct character.

- To insert a character between the input characters
- Press <<< or >>> until the cursor moves to the former of the two characters, then press ENTER and input the correct character.

Erasing the Disc Name

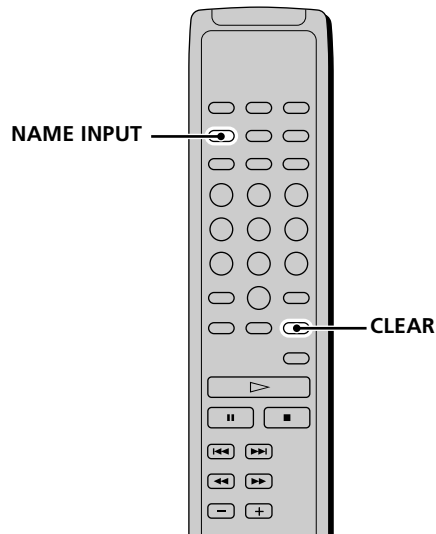

- 1 Follow Steps 1 and 3 in "Labeling Discs Using the Remote" on this page to select the Disc Name you want to erase.**
- 2 Press CLEAR repeatedly until all the characters disappear.**
- 3 Press NAME INPUT.**

Additional Information

Using the CONTROL A1II control system

This player is compatible with the CONTROL A1II Control System.

The CONTROL A1II control system was designed to simplify the operation of audio systems composed of separate Sony components. CONTROL A1II connections provide a path for the transmission of control signals that enable automatic operation and control features usually associated with integrated systems.

Currently, CONTROL A1II connections between a Sony MD deck, CD player, amplifier (receiver), and cassette deck provide automatic function selection and synchronized recording.

In the future the CONTROL A1II connection will work as a multifunction bus allowing you to control various functions for each component.

Note

The CONTROL A1II control system is designed to maintain upward compatibility as the control system is upgraded to handle new functions. In this case, however, older components will not be compatible with the new functions.

CONTROL A1II and CONTROL A1 compatibility

The CONTROL A1 control system has been updated to the CONTROL A1II which is the standard system in the Sony 300 disc CD changer and other recent Sony components. Components with CONTROL A1 jacks are compatible with components with CONTROL A1II, and can be connected to each other. Basically, the majority of the functions available with the CONTROL A1 control system will be available with the CONTROL A1II control system. However, when making connections between components with CONTROL A1 jacks and components with CONTROL A1II jacks, the number of functions that can be controlled may be limited depending on the component. For detailed information, refer to the operating instructions supplied with the component(s).

Connecting the CONTROL A1II control system

Connect monaural (2P) mini-plug cables in series to the CONTROL A1II jacks on the back of each component. You can connect up to ten CONTROL A1II compatible components in any order. However, you can connect only one of each type of component (i.e., 1 CD player, 1 MD deck, 1 tape deck and 1 receiver). (You may be able to connect more than one CD player or MD deck, depending on the model. Refer to the operating instructions supplied with the respective component for details.)

Example

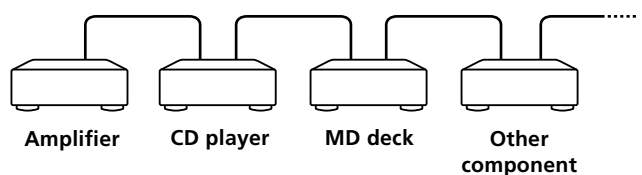

In the CONTROL A1II control system, the control signals flow both ways, so there is no distinction of IN and OUT jacks. If a component has more than one CONTROL A1II jack, you can use either one, or connect different components to each jack.

About the connecting cable

When a CONTROL A1II compatible component is not supplied with a connecting cable, use a commercially available monaural (2P) mini-plug cable less than 2 meters (6.6 feet) long, with no resistance (such as the Sony RK-G69HG).

(The monaural (2P) mini-plug cable is supplied for Canadian models.)

Basic functions of the CONTROL A1II control system

Automatic function selection

When you connect CONTROL A1II compatible Sony components using CONTROL A1II cables (not supplied), the function selector on the amplifier (or receiver) automatically switches to the correct input when you press the play button on one of the connected components.



(For example, when you press \triangleright (play button) on the CD while the MD deck is playing, the function selector on the amplifier switches from MD to CD.)

Notes

- This function works only when the components are connected to the amplifier (or receiver) inputs according to the names on the function buttons. Certain receivers allow you to switch the names of the function buttons. In this case, refer to the operating instructions supplied with the receiver.
- When recording, do not play any components other than the recording source. It will cause the automatic function selection to operate.

Synchronized recording

This function lets you conduct synchronized recording between the CD and the recording component.

- 1 Set the source selector on the amplifier (or receiver) to the CD.**
- 2 Set the CD to playing pause mode (make sure both the  and  indicators light together).**
- 3 Set the recording component to recording pause mode.**
- 4 Press  on the recording component.**

The CD is automatically released from pause mode, and recording begins shortly thereafter.

When play ends from the CD, recording stops.

Tip

Certain recorder components may be equipped with a special synchronized recording functions that uses the CONTROL AIII Control System; like "CD Synchro Dubbing." In this case, refer to the Operating Instructions supplied with the recorder component.

Note

Do not set more than one component to the pause mode.

Precautions

On safety

- Caution — The use of optical instruments with this product will increase eye hazard.
- Should any solid object or liquid fall into the cabinet, unplug the player and have it checked by qualified personnel before operating it any further.
- AC power cord must be changed only at the qualified service shop.

On power sources

- Before operating the player, check that the operating voltage of the player is identical with your local power supply. The operating voltage is indicated on the nameplate at the rear of the player.
- The player is not disconnected from the mains as long as it is attached to the mains, even if the player itself has been turned off.
- If you are not going to use the player for a long time, be sure to disconnect the player from the mains. To disconnect the mains lead, grasp the plug itself; never pull the cord.

On placement

- Place the player in a location with adequate ventilation to prevent heat build-up in the player.
- Do not place the player on a soft surface such as a rug that might block the ventilation holes on the bottom.
- Do not place the player in a location near heat sources, or in a place subject to direct sunlight, excessive dust or mechanical shock.

On operation

- If the player is brought directly from a cold to a warm location, or is placed in a very damp room, moisture may condense on the lenses inside the player. Should this occur, the player may not operate properly. In this case, remove the disc and leave the player turned on for about an hour until the moisture evaporates.
- During power on, some noise may be heard while the disc is being loaded into the Super Audio CD player. This is not a malfunction.

On adjusting the volume

- Do not turn up the volume too much while listening to a portion with very low level inputs or no audio signals. If you do, the speakers may be damaged when a peak level portion is played.

Precautions

On inserting a disc

- You may hear a transmission or a mechanical sound from the player. This indicates that the player is automatically adjusting its internal mechanisms according to the inserted disc. You may also hear the mechanical sound from the player when you insert a warped disc.

On cleaning

- Clean the cabinet, panel, and controls with a soft cloth slightly moistened with a mild detergent solution. Do not use any type of abrasive pad, scouring powder, or solvent such as alcohol or benzine.

On transportation

- Be sure to remove the disc on the tray.
- Be sure to close the disc tray.

If you have any questions or problems concerning your player, please consult your nearest Sony dealer.

Notes on Discs

On handling discs

- To keep the disc clean, handle the disc by its edge. Do not touch the surface.
- Do not stick paper or tape on the disc.

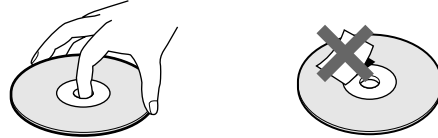

- Use only round-shaped discs. If you use a special shaped disc (e.g., star-shaped, heart-shaped, or square shaped etc.), the player may be damaged.
- Do not use a disc with a seal attached on such as on a used disc or rental disc.

On keeping discs

- Do not expose the disc to direct sunlight or heat sources such as hot air ducts.
- After playing, store the disc in its case. If you put it on top of another disc without the case, the disc may be damaged.

On placing discs on the disc tray

- Make sure the disc is positioned securely on the tray. If not, the player or the disc may be damaged.

On cleaning

- If the disc is dirty with fingerprints or dust, it may lessen the quality of the audio out.
- Before playing, clean the disc with a cleaning cloth. Wipe the disc from the centre out.

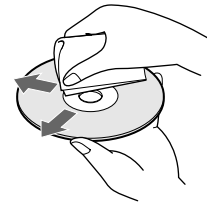

- Clean the disc with a soft cloth slightly moistened with water, and remove moisture with a dry cloth.
- Do not use solvents such as benzine, thinner, record cleaners, or anti-static spray.

Notes on CD-R/CD-RW playback

- Discs recorded on CD-R/CD-RW drives may not be played back because of scratches, dirt, recording condition, or the drive's characteristics. Besides, the discs, which are not yet finalized at the end of recording, cannot be played back.

Troubleshooting

If you experience any of the following difficulties while using the player, use this troubleshooting guide to help you remedy the problem. Should any problem persist, consult your nearest Sony dealer.

There is no sound.

- ➔ Check that the player is connected securely.
- ➔ Make sure you operate the amplifier correctly.
- ➔ When you use the headphones, adjust the volume with PHONE LEVEL.

There is no sound from the DIGITAL (CD) OUT connectors.

- ➔ The audio signals of the super audio CD cannot be output from the DIGITAL (CD) OUT connectors.

The disc does not play.

- ➔ There is no disc inside the player.
- ➔ Place the disc on the disc tray with the label side up.
- ➔ The disc is placed at an angle. Reload the disc.
- ➔ Clean the disc (see page 28).
- ➔ Moisture has condensed inside the player. Remove the disc and leave the player turned on for about an hour.
- ➔ There is an incompatible disc on the tray (see page 11).

The remote does not function.

- ➔ Remove any obstacles in the path of the remote and the player.
- ➔ Point the remote at the remote sensor on the player.
- ➔ If the batteries in the remote are weak, replace with new ones.
- ➔ Be sure that the command mode of the remote (position of the CD 1/2 switch, page 9) matches the command mode of the player (page 6).

There is no sound from the SUB WOOFER jack.

- ➔ Select the playback mode so that the Sub woofer is set to "O" (page 21).
- ➔ When you play a track that does not contain the LFE signal, the signal outputs from the SUB WOOFER jack only when you select "5 - Small + SW" or "FRT - Large + SW" for the Multi-channel playback mode (page 22).

Specifications

When a super audio CD is played

Playing frequency range 2 Hz to 100 kHz
Frequency response 2 Hz to 50 kHz (-3 dB)
Dynamic range 103 dB or more

Total harmonic distortion rate
0.0020 % or less

Wow and flutter Value of measurable limit (± 0.001 % W. PEAK) or less

When a CD is played

Frequency response 2 Hz to 20 kHz

Dynamic range 98 dB or more

Total harmonic distortion rate
0.0025 % or less

Wow and flutter Value of measurable limit (± 0.001 % W. PEAK) or less

Output connector

	Jack type	Output level	Load impedance
ANALOG OUT	Phono jacks	2 Vrms (at 50 kilohms)	Over 10 kilohms
DIGITAL (CD) OUT OPTICAL*	Square optical output connector	-18 dBm	(Light emitting wave length: 660 nm)
PHONES	Stereo phone jack	10 mW	32 ohms

*Output only the audio signals of the CD

General

Laser Semiconductor laser (SACD: $\lambda = 650$ nm) (CD: $\lambda = 780$ nm)
Emission duration: continuous

Laser radiant power: 5.47 μ W at 650 nm

*These output is the value measured at a distance of about 200mm from the objective lens surface on the optical pick-up.

Power requirements 120 V AC, 60 Hz

Power consumption 25 W

Dimensions (w/h/d) 430 \times 108 \times 400 mm (17 \times 4 1/4 \times 15 3/4 in.) incl. projecting parts

Mass (approx.) 5.9 kg (13 lbs 1 oz.)

Supplied accessories

See page 4.

Design and specifications are subject to change without notice.

Index

A

- Accessories 4
- Amplifier (not supplied) 4
- AMS (Automatic Music Sensor) 12
- ANALOG OUT
 - 5.1CH 4
 - 2CH 5

B

- Batteries 4

C

- Cable
 - Optical digital 6
- Continuous Play 11
- Cord
 - Audio connecting 4

D, E, F, G

- DIGITAL (CD) OUT 6
- Disc Name 24
- Displaying information 12

H, I, J, K

- Hooking Up
 - Audio Components 4
 - Power 6

L

- Labeling a disc 24
- Locating
 - a specific disc 16
 - a specific track 16
 - a particular point 17
 - by entering the track number 16
 - by observing the time indication (High-Speed Search) 17
 - by setting the start time (Time Search) 17
 - while monitoring the sound (Search) 17

M, N

- Multi-channel management function 21
- Multi-channel Super Audio CD 10

O

- Output level balance 22

P, Q

- Pause play 12
- Place a disc 11
- Playback mode
 - 2 channel 21
 - Multi-channel 21
- Playing
 - a disc 11
 - by entering the track number 16
 - repeatedly 18
 - track in random order 19
- Program Play
 - Checking the contents of the program 20
 - Changing the contents of the program 20
 - how to create your own program 20

R

- Remote commander (remote) 9
- Repeat
 - All Play 18
 - 1 Play 18
- Replacing discs while playing a disc 15

S

- Search
 - High-Speed Search 17
 - Time Search 17
- Shuffle Play 19
- Super Audio CD 10

T, U, V, W, X, Y, Z

- TEXT 14
- TOC 11

